

Bistable relays

RXMVB 2, RXMVB 4



RXMVB 2

(RXMVB_2.eps)



RXMVB 4

(RXMVB_4.eps)

Features

- Ac or dc voltage operated
- Electric or hand operate/reset
- Flag indication optional
- Position indication
- Two variants with 8 and 14 heavy-duty contacts with series coil cutoff contact.
- Special speeded up version of RXMVB 2 available

Application

The RXMVB relay is used in lockout applications (e.g. on transformers) and also in industry and general control where high breaking capacity bistable contacts are desired. The relay is also applied where multiple switching of current transformer secondary and trip circuits is required (e.g. from primary to backup breakers, or for zone selection in bus differential protection). The coil cut-off contacts offer the user two advantages: no continuous power consumption, thus limiting heat build-up, and no auxiliary supply load. Because of the coil cut-off contacts, this relay is also applied where the upper limit of the supply voltage can exceed the continuous voltage rating.

Design

The RXMVB is a heavy-duty permanent magnet bistable relay. When either coil is energized with the correct polarity, a repulsion occurs; and the armature switches to the other side where it locks, magnetically. The relay can be specified for ac or dc operation.

Each of the coils is wired through an additional relay contact so that the coil is deenergized after the relay switches. This contact is not recommended for any other use. To protect electronic circuits against transients a diode unit across the coils of the dc relay can be used.

For RXMVB 2 the diode is connected to 111(+) - 121(-) and 221(+) - 211(-), for RXMVB 4 to 111(+) - 122(-) and 214(+) - 212(-).

The armature assembly includes extensions through the face plate of the relay. These provide a position indication of the contacts and can also be used to operate or reset the relay manually. For occasional manual operation, a screwdriver is inserted through a small covered hole in the plastic cover. When frequent hand operation is required, a plastic cover with operate and/or reset push buttons can be ordered.

A red flag can be added to RXMVB 2 as an option. The flag indicates when the coil 121-122 has been energized. This applies to both relays.

A speeded up version of RXMVB 2 is available. The faster operating time of about 10 ms is obtained through the use of a series resistor.

A standard relay with a lower coil voltage is used with the RTXE series resistor. See table and connection diagram. The table gives also the ordering number for RTXE.

In addition it is possible to make the relay insensitive to capacitive energy discharge across the operate (and reset) coils by adding parallel resistance to the coil(s). This 10 μ F charged at 150% of nominal operating voltage can be accommodated without risking operation. This is an often found operating requirement, due to available surges in certain DC battery system due to ground faults etc.

Technical data

Type ac or dc operated	RXMVB 2		RXMVB 4	
	dc	50-60 Hz	dc	50-60 Hz
No. of contacts	8 heavy-duty bridge contacts		14 heavy-duty bridge contacts	
Reset	hand or electric			
Change-over time for contact which makes/breaks				
Typical values ms	20/15	20/15	30/25	30/20
Duty range in % of Ur	%			
	80-110			
Power consumption at Ur	During operation		During operation	
	Ur = 24 V	W	W	
	48 V	1,9	2,8	
	110 V	2,1	2,7	
	125 V	2,8	3,9	13 VA
	220 V	1,8	3,1	
	250 V	2,5	3,0	
		1,9	3,5	
Permitted ambient temperature °C	-25 to +55			
Contacts				
Max. system voltage dc/ac:				
within a contact set	V	450/400		
between sets of contacts	V	-		
Current carrying capacity (for already closed contact)				
200 ms/1 s	A	90/50		
continuously	A	10		
Making and conducting capacity L/R > 10 ms				
200 ms/1 s	A	30/20		
1 s, 2 contacts in parallel	A	30		
Breaking capacity				
ac PF > 0,1 max 250 V	A	20		
Breaking capacity dc L/R < 40 ms				
	Ur = 24 V	A	20	
	48 V	A	12	
	110 V	A	3	
	125 V	A	2,5	
	220V	A	1	
	250 V	A	0,8	
Insulation tests:				
Dielectric tests, 50 Hz, 1 min	kV	2,5		
Impulse voltage test, 1,2/50 µs, 0,5 J	kV	5,0		
Dimension (U and C)	2U 12C		4U 12C	
Weight (kg)	0,5		1	

Diagram & Ordering

Specify:

- Type
- Quantity
- Ordering No. (consists of number and letters for the rated voltage); example: RK 251 204-AD

RXMVB 2

No. selection table

RK 251 204-..

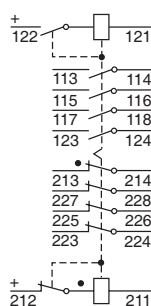

RK 251 205-..

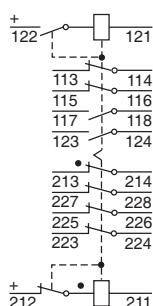

RK 251 206-..

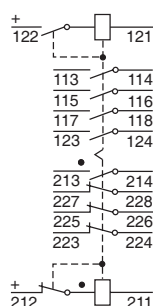

RXMVB 4

No. selection table

RK 251 401-..

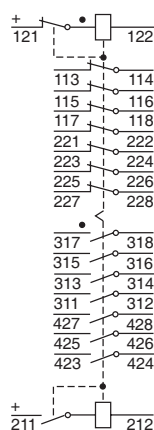

RK 251 402-..

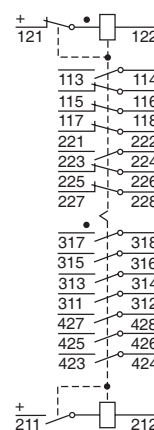

RK 251 403-..

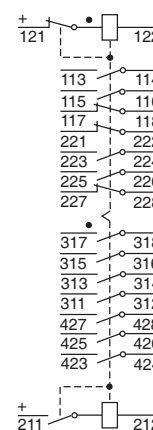

When the winding terminal marked with a dot is positive the contact moves to the position marked with a dot.

For RXMVB 2 left coil has terminals 122-121. For RXMVB 4 upper coil has terminals 121-122.

Letter selection table, dc and ac rated voltage V, RXMVB

24	48	110	110-127	125	220	250	380
dc							
AD	AH	AN	-	AP	AS	AT	-
ac 50-56 Hz							
-	-	-	AD	-	AH	-	AN

Other contact combinations and voltages are available on request.

Diagram & Ordering

Speeded up version with series resistor and red flag 110 V and 220 V DC rated voltage. This version shall not be used for manually operation.

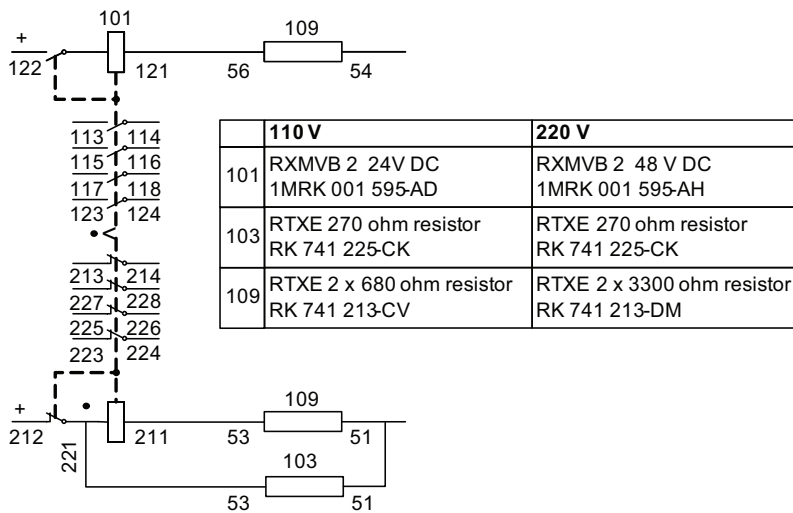

Handling of capacitive discharge currents into relay by using parallel resistor (103)

SE13000057.eps

Relay with operate and/or reset push buttons			Flag and push button
Relay type	Push button position	Ordering No.	Ordering No.
RXMVB 2 ¹⁾	Right and left	RK 251 900-XE	RK 251 900-XM
	Right	RK 251 900-XD	RK 251 900-XN
	Left	RK 251 900-XC	RK 251 900-XP
RXMVB 4 ¹⁾	Upper and lower	RK 251 900-XF	-
	Upper	RK 251 900-XG	-
	Lower	RK 251 900-XH	-

¹⁾ Specify the basic relay ordering No.

Relay with red flag	
Relay type	Ordering No.
RXMVB 2	RK 251 900-XL
RXMVB 4	RK 251 900-XR

¹⁾ Specify the basic relay ordering No.

Plastic covers with operate and/or reset push buttons for separate delivery		
Relay type	Push button position	Ordering No.
RXMVB 2 ¹⁾	Right and left	5283 0086-A
	Right	5283 0086-B
	Left	5283 0086-C
RXMVB 4	Upper and lower	1228 268-A
	Upper	1228 268-B
	Lower	1228 268-C

¹⁾ Specify the basic relay ordering No.

References

Relay mounting systems 1MRK 514 001-BEN

Auxiliary relays, Self-reset and bistable 1MRK 508 015-UEN

Contact us

ABB AB

Substation Automation Products

721 59 Västerås, Sweden

Phone: +46 (0) 21 32 50 00

www.abb.com/substationautomation

ABB Limited

Plot no. 4A, 5 & 6, II Phase

Peenya Industrial Area

Bangalore - 560 058.

India

Phone: +91 80 2294 9632

Facsimile: + 91 80 2294 9188

Note:

We reserve the right to make technical changes or modify the contents of this document without prior notice. ABB AB does not accept any responsibility whatsoever for potential errors or possible lack of information in this document.

We reserve all rights in this document and in the subject matter and illustrations contained herein. Any reproduction, disclosure to third parties or utilization of its contents – in whole or in part – is forbidden without prior written consent of ABB AB.

© Copyright 2013 ABB.

All rights reserved.